



Lifting Your Business to A Higher Level

# USER MANUAL

## PLATE CLAMP (UNIVERSAL & HORIZONTAL)

HPC-1: 143075, 143100, 143150, 143200, 143300, 143500

UPC-1: 142075, 142150, 142200, 142300, 142500



1300 100 120

[www.austlift.com.au](http://www.austlift.com.au)

AUSTRALIAN LIFTING CENTRE PTY LTD



**WARNING**  
**New operator must be trained prior to use!**

## Universal Plate Clamp (UPC-1)

The AUSTLIFT model UPC-1 Clamp is designed for a wide range of uses for vertical lifting and is particularly suited for lifting and turning of steel plates of up to 180°. This clamp can be applied to a wide range of applications such as ship sections and the extraction of pile sheets which maintains a structure for safety against ground touching shocks of the loads.

The AUSTLIFT model UPC-1 Clamps are fitted with a hinged hoisting eye to allow movement in all directions. The clamp is fitted with a safety lock device by which the lock will not disengage even if the lifting sling has been slackened, this guarantees the clamp will not disengage in both open as well as closed positions.

- The clamp is suited to steel surface hardness of up to 37 RC.
- Individually serial numbered with test certificates and user manual.
- Spare parts are available.

AS/NZS  
4991

Certified

Instruction  
Manual

WLL From  
0.75-5t



# Specifications

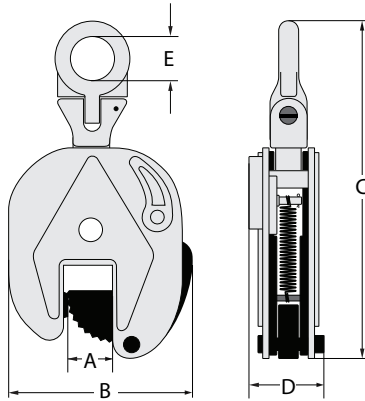

WLL (T)	CODE	Wt. (kg)	DIMENSION (mm)				
			A	B	C	D	E
0.75	142075	2	0-15	105	218	51	φ30
1.5	142150	7.4	0-20	170	370	70	φ60
2	142200	7.8	0-25	175	375	72	φ60
3	142300	16	0-30	195	418	98	φ60
5	142500	23	0-50	230	480	110	φ80

## Application

- High strength and durable
- Identification tag with serial number
- Proof tested to 2 x WLL with certificate
- Minimum Safety factor of 5:1
- Spare parts are available

## Features

- Building construction sites
- Ship building yards
- Metal production workshops
- Civil engineering construction
- Railway construction sites



**WARNING**  
**New operator must be trained prior to use!**

## Horizontal Plate Clamp

The AUSTLIFT model HPC-1 Clamp is used in pairs to horizontal lift and transport steel material on a flat plane configuration. It is particularly suited to this application due to the thin pressure pad and buffer cams which facilitate easy insertion and removal under the plate being lifted. Also fitted is an open jaw lock feature which aids for easy positioning before lifting. The jaw is spring loaded to prevent slippage of the load before lifting. It can also be used hanging vertically under a spreader beam.

AUSTLIFT model HPC-1 Clamps are light weight relative to their lifting capacity.

- Please note that the work load limit of these horizontal clamps is based on a pair or more. The clamp is suited to a steel surface hardness of up to 37 RC.
- Individually serial numbered and comes with test certificates and user manual.
- Spare parts are available

AS/NZS  
4991

Certified

Instruction  
Manual

WLL From  
0.75-5t



# Specifications

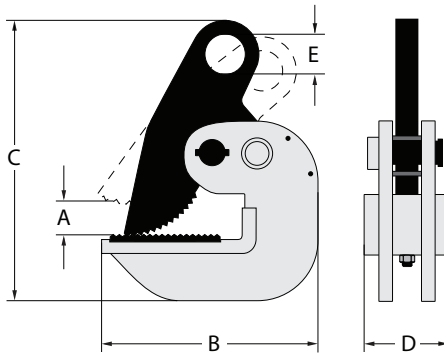

Fitted with locking button  
(a safety feature)

WLL (T)	CODE	Wt. (kg)	DIMENSION (mm)				
			A	B	C	D	E
0.75	143075	3.5	0-25	125	175	51	φ25
1	143100	4	0-30	161	205	60	φ30
1.5	143150	4.3	0-30	161	205	60	φ30
2	143200	7.2	0-40	175	245	65	φ30
3	143300	8	0-45	180	250	65	φ30
5	143500	9	0-55	185	260	70	φ30

## Application

- Building construction sites
- Ship building yards
- Metal production workshops
- Civil engineering construction
- Railway construction sites

## Features

- High strength and durable.
- Identification tag with serial number
- Proof tested to 2 x WLL with certificate.
- Minimum Safety factor of 5:1
- Spare parts are available

## Pre Use Inspection

All plate clamps should be examined prior to use. If any of the following defects are present they should be withdrawn from service and referred to a competent person:

### Vertical and Horizontal

- Blunted teeth in either fixed or movable jaws.
- Frame opened out
- Worn or bent pins
- Mechanism not working freely
- Wear on gripping surfaces
- Nicks, cracks, cuts, gouges or corrosion present

### Vertical only

- Broken or stretched spring in locking lever
- Unsatisfactory action of the locking lever
- Tight bent or damaged clamping threads



## DO NOT USE IT

Ensure clamps are inspected prior to use



### DO NOT USE IT

If the clamp is damaged it should be taken out of service until it is repaired and certified by an authorised person for reuse, and always use genuine Austlift parts.

### DO NOT USE IT

If any of the gripping jaws show more than two teeth missing

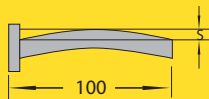

### DO NOT USE IT

If the main shaft pin is bent more than 1.5mm (S) over 100mm of length of the main shaft pin



### DO NOT USE IT

If the main shaft pin is worn more than 5% of its original diameter



### DO NOT USE IT

If the tooth wear exceed to limit (A)  
 WLL 0.75t - 1.5t = 0.8mm  
 WLL 2.5t - 5t = 1.0mm  
 WLL 5t - 16t = 1.2mm

## How to use Universal Plate Clamp

1. Push the spring loaded safety lock arm (A) downwards, this will neutralize the gripping jaw (B).
2. Place the clamp over the plate to be lifted making sure the plate sits all the way in the back of the jaw and the safety latch sits upward from horizontal position.
3. Re-engage the safety lock arm (A) and let the spring loaded cam push down on the plate ensuring both pressure pad (C) and grip cam (B) are in full contact with the steel plate. Ensure the Safety lock arm is returned to a fully locked position (this can be tight on thicker steel plates).
4. To remove the clamp first ensure the plate is safely on the ground then place one hand on the body of clamp and release the safety lock arm (A) and push down the hoisting eye (D) to release the gripping cam (this can release quickly on thicker steel plates).

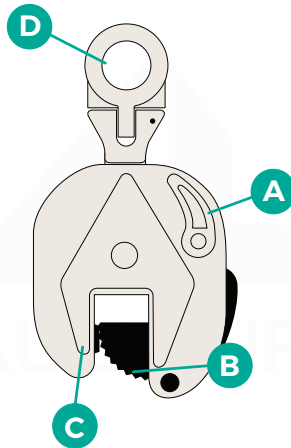

## Care in Use

### Lifting Methods of Universal Plate Clamps

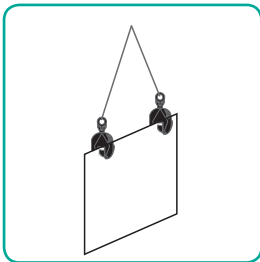

STEEL PLATE WITH 2 CLAMPS

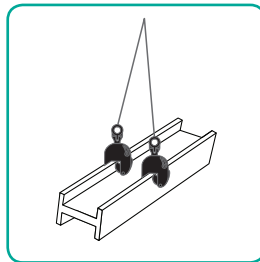

STEEL GIRDERS

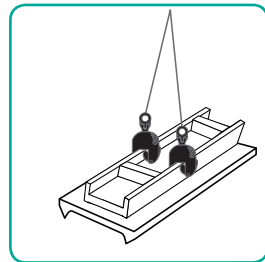

FABRICATED OBJECTS

## How to use Horizontal Plate Clamp

1. Push the spring loaded gripping arm (A) downward until the lock pin (C) clicks into place and remains engaged.
2. Place the clamp over the plate to be lifted making sure the plate sits all the way in the back of the jaw. Push lock button (C) and let the spring loaded cam release and push down on the plate ensuring both pressure pad (B) and grip cam (A) are in full contact to steel plate.
3. Ensure rated lifting equipment is used and attached correct eye of the clamps are connected.

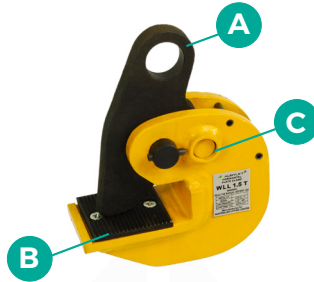

## Care In Use

### Lifting Methods of Horizontal Plate Clamps

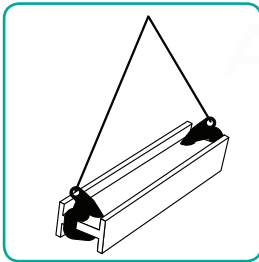

STEEL GIRDERS

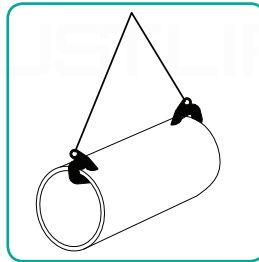

STEEL PIPES

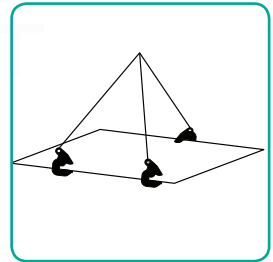
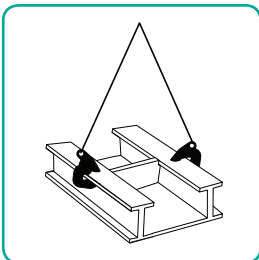

PLATE WITH 3 CLAMPS



FABRICATED OBJECTS

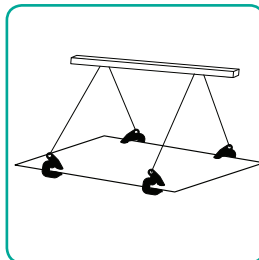

PLATE USING SPREADER BAR

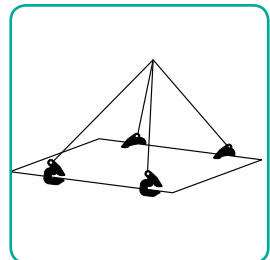
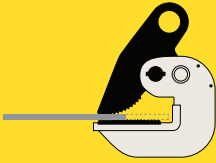
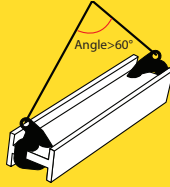

PLATE WITH 4 CLAMPS

# ! DANGER Incorrect Application for Horizontal Clamps



**DANGER**  
Superficial Gripping



**DANGER**  
Sling Angle Exceeds 60°

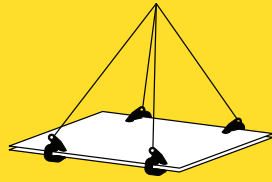

**DANGER**  
Lifting Two Plates Simultaneously

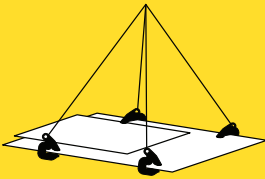

**DANGER**  
Lifting Two different size plates simultaneously

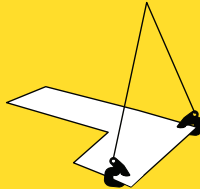

**DANGER**  
One Side Lifting

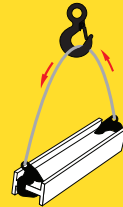

**DANGER**  
Two point lifting using one sling

AUSTLIFT

## Storage and Handling

- All plate clamps other than those fixed permanently in position should, after use, be returned to safe storage. The general requirements are essentially that the storage should be dry, free from pollutions likely to cause damage or corrosion and extremes of temperature. Equipment prior to storage should be checked that the unit remains in good working order and that all parts are present.
- When being handled the clamps should not be dropped or thrown.

## Warning

- Ensure the steel plate is to the full depth of the clamp.
- Make sure the clamps are positioned to the centre of gravity of steel plate.
- With long steel objects a spreader beam shall be used.
- Ensure the gripping jaws are in full contact to steel plate.
- Full work load limit of clamps do not exceed sling angles more than 60°.
- Reduction of plate clamps work load limits at 90° = 75% of WLL & 120° = 50% of WLL



**WARNING**  
**Observe these notes for plate clamps!**

# Spare Parts for Universal Plate Clamp

## UNIVERSAL CLAMP PLATE CLAMP TECHNICAL DRAWING

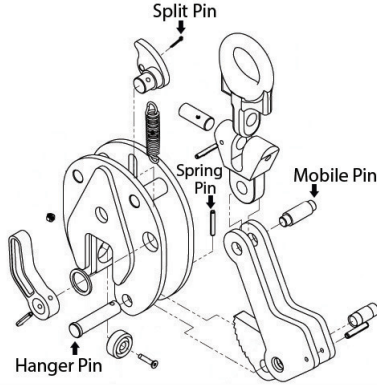

## UNIVERSAL CLAMP PLATE CLAMP REPAIR KITS

### LITTLE PAD



### ACTION JACK (BRAKE ASSEMBLY)



WLL	CODE	SUIT	WLL	CODE	SUIT
0.75T	031075SP1	142075	0.75T	031075SP2	142075
1.5T	031150SP1	142150	1.5T	031150SP2	142150
2T	031200SP1	142200	2T	031200SP2	142200
3T	031300SP1	142300	3T	031300SP2	142300
5T	031500SP1	142500	5T	031500SP2	142500

## Horizontal Plate Clamp Repair

### Disassembly Steps

- 1** Use tools to knock the spring pin off, then pull the hanger pin out.

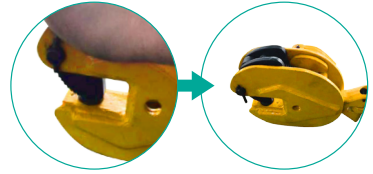

- 2** Use the tool to knock the hanger pin off, then remember to keep the hanger pin and the two shims together.

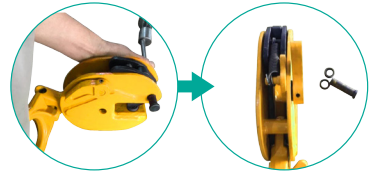

- 3** Pull out the split pin.

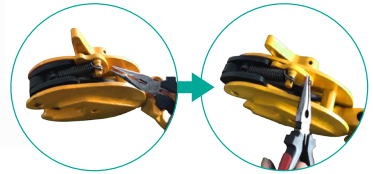

- 4** Use tools to knock the spring pin off, then pull the hanger pin out.



- 5** Push the mobile pin out with your finger.



## Reassembly Steps

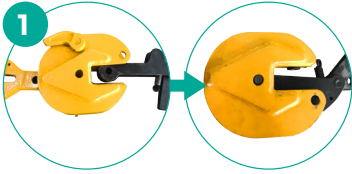

Align the eyelet hole, the body hole, and the connecting rod hole so that the three holes are at the same center point



Insert the mobile pin into the hole and pull the brake to fit the groove (Figure 3)



Assemble the connector, the lower pin, the spring, etc.

**Note: All structural repair or subsequent work to load-bearing components must be carried out in accordance with AS4991.**

# Spare Parts for Horizontal Plate Clamp

LIFTING PLATE CLAMP  
HPC-1 & UPC-1 SERIES

USER INSTRUCTION MANUAL

## HORIZONTAL CLAMP PLATE CLAMP TECHNICAL DRAWING

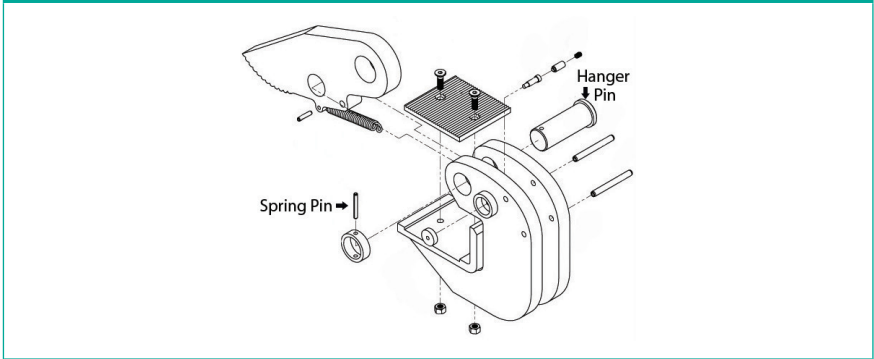

## HORIZONTAL CLAMP PLATE CLAMP REPAIR KITS

LITTLE PAD			ACTION JACK (BRAKE ASSEMBLY)		
WLL	CODE	SUIT	WLL	CODE	SUIT
0.75T	032075SP1	143075	0.75T	032075SP2	143075
1T	032100SP1	143100	1T	032100SP2	143100
1.5T	032150SP1	143150	1.5T	032150SP2	143150
2T	032200SP1	143200	2T	032200SP2	143200
3T	032300SP1	143300	3T	032300SP2	143300
5T	032500SP1	143500	5T	032500SP2	143500

# Horizontal Plate Clamp Repair

## Disassembly Steps



Use tools to knock the spring pin off, then pull the hanger pin out.



Use the tool to knock the hanger pin off, then the main components are dismantled including brake assembly.

## Reassembly Steps



Put the brake into the body of clamp and align the center of the holes of brake and the body.

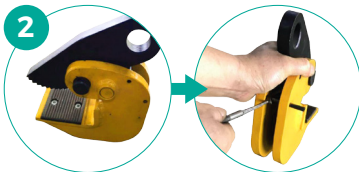

Insert the the hanger pin and remember to connect the spring pin and the rear spring pin.



Knock the corresponding spring pin into the body.

**Note:** All structural repair or subsequent work to load-bearing components must be carried out in accordance with AS4991.

# AL AUSTLIFT®

Wholesale of Lifting, Rigging, Load Restraint  
& Height Safety products

## AUSTRALIAN LIFTING CENTRE



**1300 100 120**

[www.austlift.com.au](http://www.austlift.com.au)

### Head Office (NSW)

 43 Frank Street  
Wetherill Park, NSW 2164  
 Ph: 02 9757 2277

### QLD Office

 7 Durbell Street  
Acacia Ridge, QLD 4110  
 Ph: 07 3272 0777

### WA Office

 42 Mulgool Road  
Malaga, WA 6090  
 Ph: 08 9248 6674

### VIC Office

 47 Technology Drive  
Sunshine West, VIC 3020  
 Ph: 03 9314 5525